

APMS150C105UD LED Drivers

Replacement BU Voltage driver for use on Appleton™ 13,500 and 17,500 Lumen Mercmaster™ LED Generation 3, 13,500 and 17,500 Lumen Industrial Mercmaster™ LED Generation 3, 15K and 19K Lumen Areamaster™ Generation 2 LED, 15K and 19K Lumen Industrial Areamaster™ Generation 2 LED, 30K and 38K Lumen Areamaster™ Generation 2 HL LED, 30K and 38K Lumen Industrial Areamaster™ Generation 2 HL LED, 15K and 19K Lumen Baymaster™ LED and 15K and 19K Lumen Industrial Baymaster™ LED, 30K and 38K Lumen Baymaster™ HL LED and 30K and 38K Lumen Industrial Baymaster™ HL LED.

Features

- Input voltage: 90–305 Vac
- Built-in active PFC function 0.98 typ.
- High efficiency: up to 92% typ.
- Built-in lightning protection
- Three dimming in one operation modes (0–10 V dimming/clock dimming (CLK)/PWM dimming)
- Protection: OVP, SCP, OTP
- Full power at 65% I_o max ~ 100% I_o max (constant power)
- IP67 design for indoor or outdoor installations



NEC/CEC Compliances

- UL8750, UL1012, EN61347-1
- EN61347-2-13, EN60598-1, EN62384

Output Current	Input Voltage	Max. Output Power	Typical Efficiency	Typical Power Factor	Used in BU Luminaire Models	Part Number
650 mA	90-305 Vac 125-300 Vdc	150 W	90%	0.98	AMLGL7W and AMLHL2W BLLL7W and BLLPL7W BHLL2W and BHLPL2W	APMS150C105UD65
680 mA	90-305 Vac 125-300 Vdc	150 W	90%	0.98	AMLGL7C and AMLHL2C BLLL7C and BLLPL7C BHLL2C and BHLPL2C	APMS150C105UD68
720 mA	90-305 Vac 125-300 Vdc	150 W	90%	0.98	MLGH3	APMS150C105UD72
890 mA	90-305 Vac 125-300 Vdc	150 W	90%	0.98	AMLGL8W and AMLHL3W BLLL8W and BLLPL8W BHLL3W and BHLPL3W	APMS150C105UD89
900 mA	90-305 Vac 125-300 Vdc	150 W	90%	0.98	MLGH6	APMS150C105UD90
915 mA	90-305 Vac 125-300 Vdc	150 W	90%	0.98	AMLHL3C BHLL3C/BHLPL3C	APMS150C105UD91
930 mA	90-305 Vac 125-300 Vdc	150 W	90%	0.98	AMLGL8C BLLL8C/BLLPL8C	APMS150C105UD93

Dimensions in Millimeters (Inches)

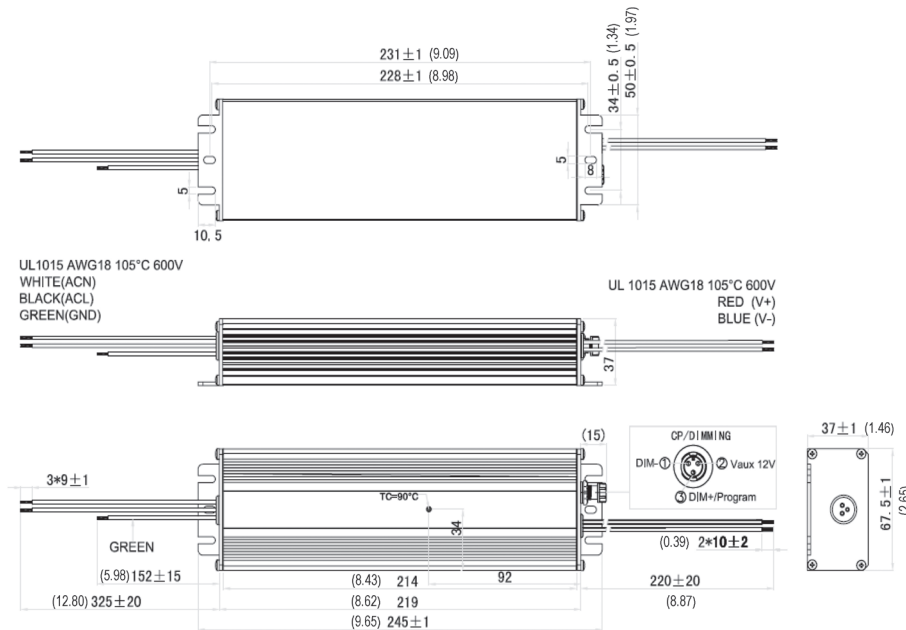

APMS150C105UD LED Drivers

Replacement BU Voltage driver for use on Appleton™ 13,500 and 17,500 Lumen Mercmaster™ LED Generation 3, 13,500 and 17,500 Lumen Industrial Mercmaster™ LED Generation 3, 15K and 19K Lumen Areamaster™ Generation 2 LED, 15K and 19K Lumen Industrial Areamaster™ Generation 2 LED, 30K and 38K Lumen Areamaster™ Generation 2 HL LED, 30K and 38K Lumen Industrial Areamaster™ Generation 2 HL LED, 15K and 19K Lumen Baymaster™ LED and 15K and 19K Lumen Industrial Baymaster™ LED, 30K and 38K Lumen Baymaster™ HL LED and 30K and 38K Lumen Industrial Baymaster™ HL LED.

Diagrams

Derating Curve

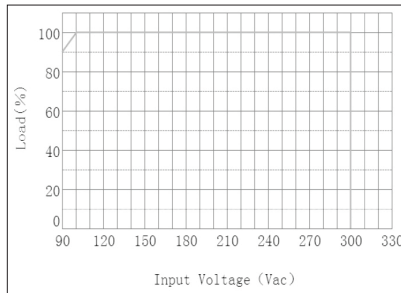

Power Factor vs. Load Curve

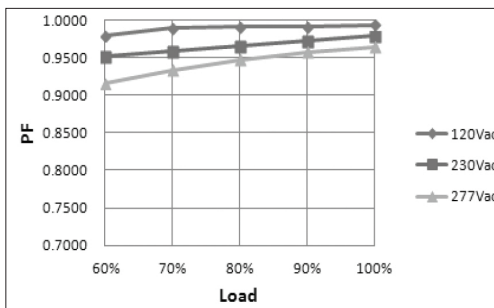

THD Curve

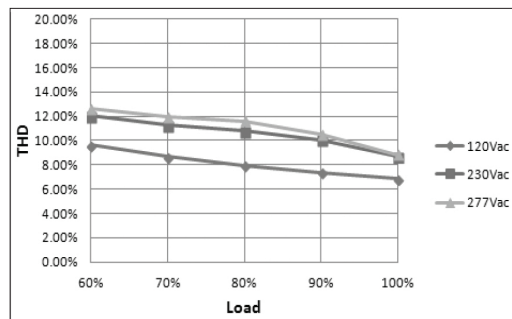

Efficiency vs. Load Curve

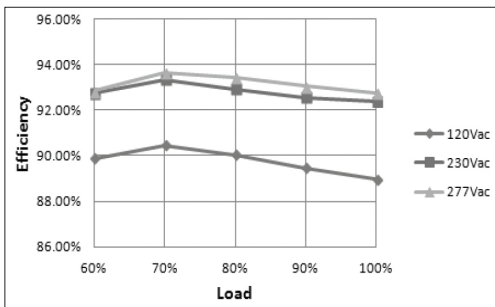

Lifetime vs. Driver Tcase

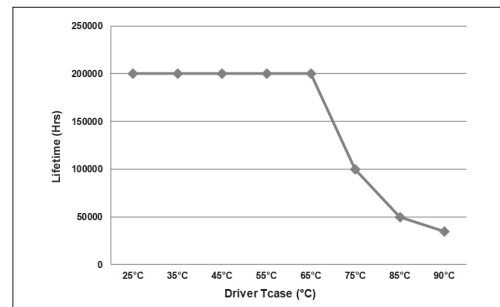

OTP

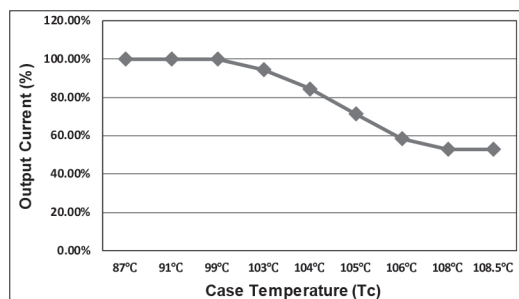

APMS150C105UD LED Drivers

Replacement BU Voltage driver for use on Appleton™ 13,500 and 17,500 Lumen Mercmaster™ LED Generation 3, 13,500 and 17,500 Lumen Industrial Mercmaster™ LED Generation 3, 15K and 19K Lumen Areamaster™ Generation 2 LED, 15K and 19K Lumen Industrial Areamaster™ Generation 2 LED, 30K and 38K Lumen Areamaster™ Generation 2 HL LED, 30K and 38K Lumen Industrial Areamaster™ Generation 2 HL LED, 15K and 19K Lumen Baymaster™ LED and 15K and 19K Lumen Industrial Baymaster™ LED, 30K and 38K Lumen Baymaster™ HL LED and 30K and 38K Lumen Industrial Baymaster™ HL LED.

Specifications ①

Input	Efficiency (120 Vac) (Typ.) ②	89.0%
	Efficiency (230 Vac) (Typ.) ②	92.0%
	Voltage Range (V)	90–305 Vac, 125–300 Vdc (min.–max.)
	Frequency Range (Hz)	47 ~ 63
	Power Factor (Typ.)	>0.95 with 100% load, at 100 Vac–277 Vac 0.90 (Typ.) with 60% ~ 100% load, at 100 Vac–277 Vac/60 Hz
	THD (Typ.)	<15% at 220 Vac input 50 Hz, 80% ~ 100% load <20% at 100 Vac - 277 Vac/60 Hz input, 60% ~ 100% load
	AC Current (Typ.)	1.8 A at 100 Vac input, 0.9 A at 230 Vac
	Inrush Current (Max.)	65 A at 230 Vac input +25 °C Cold Start (time wide=500 uS, measured at 50% I _{peak})
	Leakage Current (Max.)	0.75 mA at 277 Vac/60 Hz input
Output	Voltage Range (V) ③	214–86
	Output Current Range (mA)	70–1050
	Rated Power (W)	150 (max.)
	Output Current Settable Range	0.45 to 1.05 A dc
	Constant Power Output Set	65% I _{o_max} ~ 100% I _{o_max}
	Ripple & Noise Current (Typ.)	10% max. ((PK-AV) /AV), full load)
	Current Tolerance (I _{max})	±5%
	Line Regulation (I _{max})	±3%
	Load Regulation (I _{max})	±5%
	Turn On Delay Time	<1.2s, at 120 Vac; <1s, at 277 Vac
Dimming Control	12Vdc Output Voltage (Vdc)	10.8 V min. ~ 13.2 V max.
	12Vdc Output Current (mA)	0 mA ~ 20 mA max.
	0 ~ 10V/DIM+ Voltage	Absolute maximum voltage -10 V min ~ 20 V max
	0 ~ 10V/DIM+ Short Current	280 uA ~ 450 uA (DIM(+)=0)
	Dimming Function	Default is 0–10 V dimming mode; others dimming ways like PWM/CLK. Dimming can set by software configuration

APMS150C105UD LED Drivers

Replacement BU Voltage driver for use on Appleton™ 13,500 and 17,500 Lumen Mercmaster™ LED Generation 3, 13,500 and 17,500 Lumen Industrial Mercmaster™ LED Generation 3, 15K and 19K Lumen Areamaster™ Generation 2 LED, 15K and 19K Lumen Industrial Areamaster™ Generation 2 LED, 30K and 38K Lumen Areamaster™ Generation 2 HL LED, 30K and 38K Lumen Industrial Areamaster™ Generation 2 HL LED, 15K and 19K Lumen Baymaster™ LED and 15K and 19K Lumen Industrial Baymaster™ LED, 30K and 38K Lumen Baymaster™ HL LED and 30K and 38K Lumen Industrial Baymaster™ HL LED.

Specifications ①		
Protection	Over Voltage (V)	280 V max. No damage. The power supply shall be self-recovery when the fault is removed.
	Short Circuit	Protection type: Constant current limiting.
	Over Temperature	Decreases output current, returning to normal after over temperature is removed. (See OTP plot.)
Environment	Operating Humidity	20 ~ 95% RH, non-condensing
	Tc	-40 °C to +90 °C (max.)
	Storage Temp., Humidity	-40 °C ~ +85 °C, 10-95% RH
	Vibration	10-500 Hz, 5G 12 min./cycle, period for 72 min. each along X, Y, Z axes
Safety & EMC	Safety Standard	UL8750, UL1012, EN61347-1, EN61347-2-13, EN60598-1, EN62384
	Withstand Voltage	I/P-O/P:3.75K Vac I/P-FG:1.875KV O/P-FG:1.5KV
	Isolation Resistance	I/P-O/P, I/P-FG, O/P-FG:100M Ohms/500Vdc/25°C/70%RH
	EMC Emission	EN55015/FCC Part 15 Class B, EN61000-3-2 Class C, EN61000-3-3
	EMC Immunity	EN61000-4-2,3,4,5,6,8,11, EN61000-4-5: Line to Neutral: ±6kV ; Line to GND: ±6kV; Neutral to GND: ±6kV. IEEE / ANSI C62.41.2 Transient Surge Requirements, combi wave 2 ohm source impedance.
Others	MTBF	300,000 Hours, measured at full load, +25 °C ambient temperature
	Lifetime	Refer to plot.
	Dimension	221 x 67.5 x 40 mm (L x W x H); (8.70 x 2.66 x 1.46 inches)
	Weight	1550 g (2.31 lb)

① All parameters NOT specially mentioned are measured at 230 Vac input, rated load and 25°C of ambient temperature

② Measured at full load and steady-state temperature in 25°C ambient (Efficiency will be about 2% lower if measured immediately after startup)

③ Refer to V/I curve